

显示模式: TN反射正显灰膜
 驱动条件: 3.3V, 1/4Duty, 1/3Bias
 视角: 6
 温度范围: -20,70度工作, -30,80度储存
 尺寸: 长30.0*宽15.0mm, 反射模式

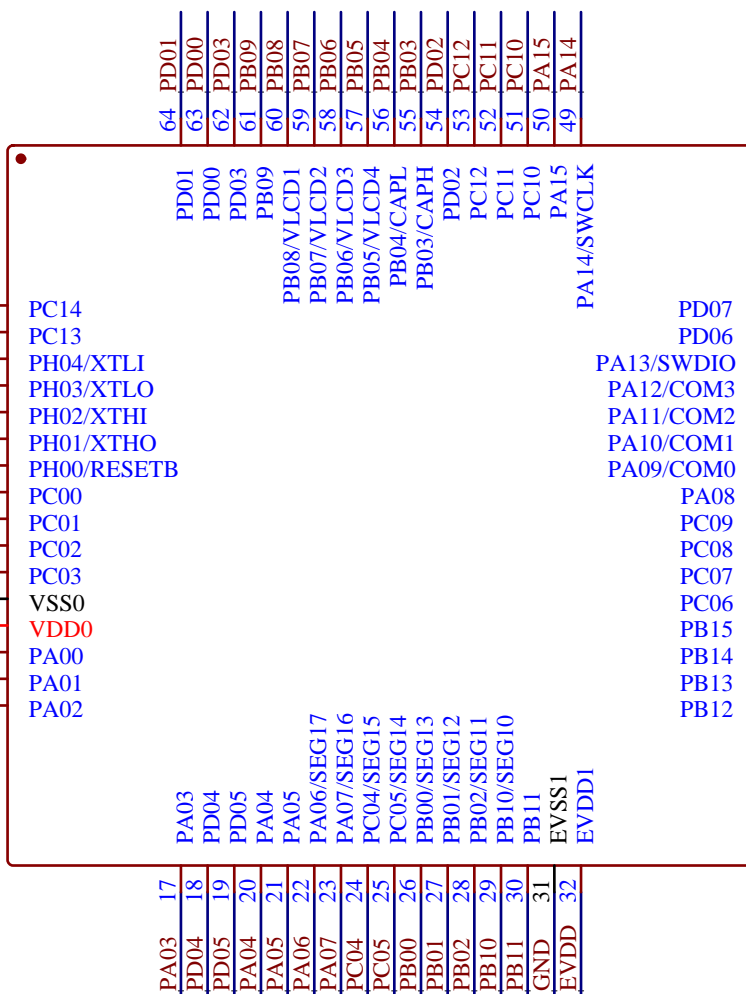

U1 BAT32G127GH64FB

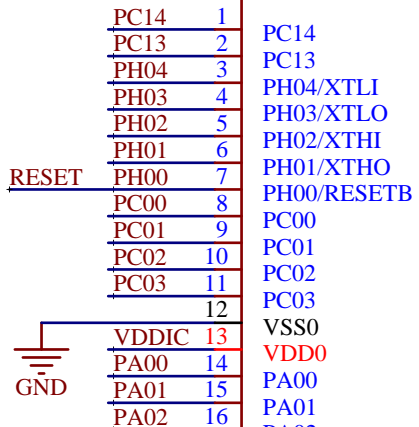
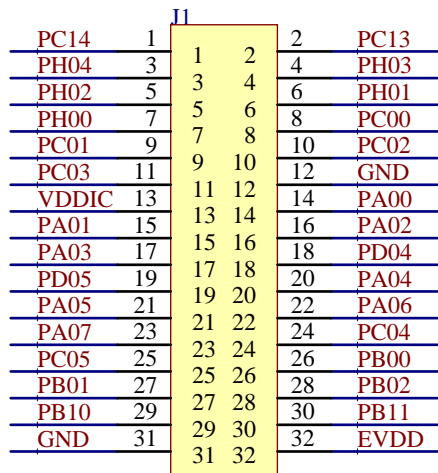
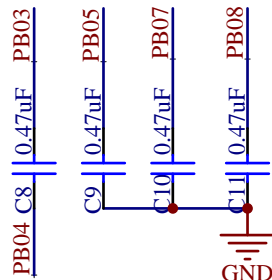
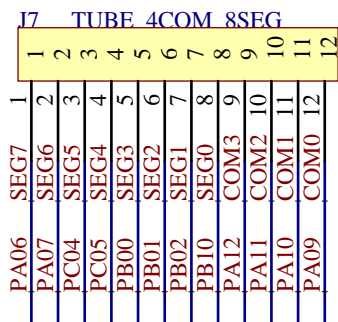
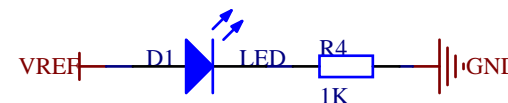
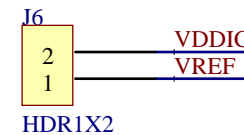
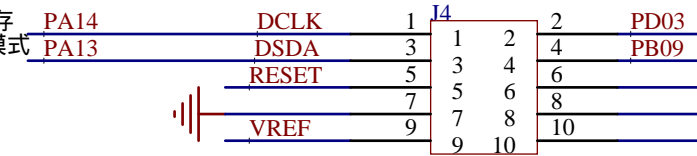
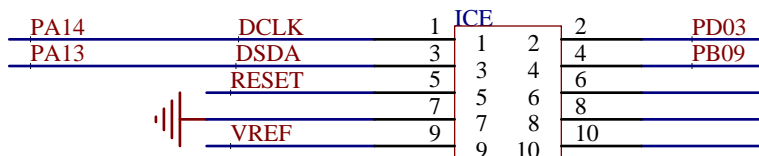